

MIXPAC™ Systems for Adhesives

2-Component Industry

Innovation in Application





Table of Content

MIXPAC™ A-System.....	6
MIXPAC™ B-System.....	10
MIXPAC™ C-System	18
MIXPAC™ F-System	24
MIXPAC™ K-System.....	30
MIXPAC™ Blueline.....	34
MIXPAC™ Machine Mixers	38



Overview

Industry Systems

The Mixpac **A-System** is suitable for dispensers with 50mL volume, mixing ratios 1:1, 2:1, 4:1, 10:1, combinable with dedicated mixing tips.

MIXPAC™
A-System

The Mixpac **Machine Mixers** assortment includes lengths, diameters, mixer tips and other accessories.

MIXPAC™
Machine Mixeres

The Mixpac **F-System** is manufactured from high quality, chemical resistant plastics to meet stringent shelf-life stability and metering requirements for your formulated products. Suitable for dispensers up to 400mL volume, mixing ratios 1:1, 2:1, 4:1, 10:1, combinable with Helix and Quadro mixing tips.

MIXPAC™
F-System

MIXPAC™
Blueline

The Mixpac **Blueline** System is suitable for high viscosity material that is difficult to dispense and for material with flow issues. Available for 400mL cartridges, mixing ratios 2:1, 10:1, combinable with T-mixer mixing tips.

MIXPAC™
K-System

The Mixpac **K-System** is suitable both for industry as well as DIY users. Thanks to a range of mixing ratios, materials and colors.

MIXPAC™
C-System

The Mixpac **C-System** is manufactured from high quality, chemical resistant plastics to meet stringent shelf-life stability and metering requirements for your formulated products. Suitable for dispensers up to 400mL volume, mixing ratios 1:1, 2:1, 4:1, 10:1, combinable with dedicated mixing tips.

MIXPAC™
B-System

The Mixpac **B-System** meets the growing demand in the industrial and trade markets for reliable, safe, easy-to-use application systems for 2-component adhesives and sealants. Suitable for dispenser volume 25mL, 50mL and 75mL, mixing ratios 1:1, 2:1, 4:1, 10:1, combinable with Helix and Quadro mixing tips.



MIXPAC™ A-System Overview

50/75mL Industrial Set

ACCESSORIES

Accessories

	ID	Article
	101651	BRT 205-10
	102274	IOT 406-15
	102277	IOT 506-15
	102356 102357	LA 05-00 LA 06-08

Outlet Tip

-  Tapered Tip (S)
-  Straight Tip (D)
-  Luer Slip Tip (L)
-  Stepped Tip (T)

MIXER



○ MAH (Helix)

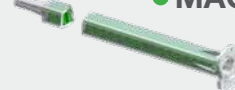

● MAQ (Quadro)

50mL

CARTRIDGE

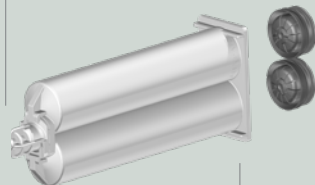

1:1

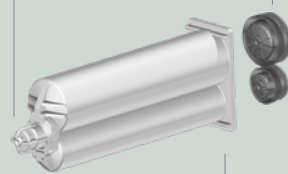

2:1

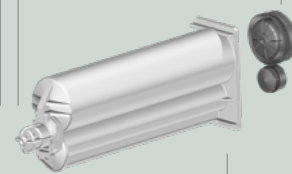

4:1

DISPENSER



● DMA

Piston Retention Plate



Ratio	ID	Article
1:1/2:1	103213	PR 050-01-02 
4:1/10:1	103214	PR 050-04-10 



● MAHX (Helix)

75mL

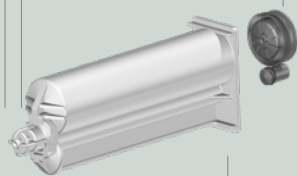

10:1

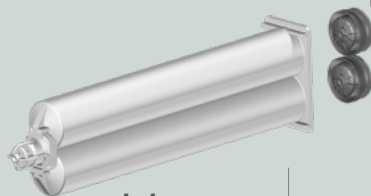

1:1



● DP



MIXPAC™ A-System Cartridge Set

50/75 Industrial Set Cartridge Assembly 50/75mL





Ratio Set/ Volume	ID	Article	Cartridges Material/ Color	Piston Type/ Material	O-ring	Units/ Box	Mixer Technology	Matching Dispenser	
1:1 50mL	110353	AA 050-01-10-01	PP/○	PP, self-venting	-	1250	MAH ○ MAQ ●	DMA ● DP ●	
	112781	AA 050-01-10-02	PP/○	PP, self-venting	EPDM	1250	MAH ○ MAQ ●	DMA ● DP ●	
	110507	AA 050-01-10-03	PP/○	PP	EPDM	1250	MAH ○ MAQ ●	DMA ● DP ●	
	116606	AA 050-01-10-05	PP/●	HDPE, solid piston	EPDM	1250	MAH ○ MAQ ●	DMA ● DP ●	
	116878	AA 050-01-10-06	PP/○	A-piston self-venting lip seal piston PA with EPDM O-ring, B-Piston self-venting lip, seal piston PP	EPDM	1250	MAH ○ MAQ ●	DMA ● DP ●	
	154840	AA 050-01-10-33	PP/○	HDPE, self-venting	-	1250	MAH ○ MAQ ●	DMA ● DP ●	
	154826	AA 050-01-10-34	PP/○	HDPE, self-venting	EPDM	1250	MAH ○ MAQ ●	DMA ● DP ●	
	116221	AA 050-01-30-01	PA/○	PA, self-venting	-	1250	MAH ○ MAQ ●	DMA ● DP ●	
	116415	AA 050-01-30-02	PA/○	PA, self-venting	EPDM	1250	MAH ○ MAQ ●	DMA ● DP ●	
	154841	AA 050-01-30-33	PA/○	HDPE, self-venting	-	1250	MAH ○ MAQ ●	DMA ● DP ●	
	154852	AA 050-01-30-37	PA/●	HDPE, self-venting	-	1250	MAH ○ MAQ ●	DMA ● DP ●	
	1:1 75mL	116107	AA 075-01-10-01	PP/○	PP, self-venting	-	625	MAH ○ MAQ ●	DMA ● DP ●
		116420	AA 075-01-10-02	PP/○	HDPE, solid piston	EPDM	625	MAH ○ MAQ ●	DMA ● DP ●
154874		AA 075-01-10-33	PP/○	HDPE, self-venting	-	625	MAH ○ MAQ ●	DMA ● DP ●	
154876		AA 075-01-10-34	PP/○	HDPE, self-venting	EPDM	625	MAH ○ MAQ ●	DMA ● DP ●	
2:1 50mL		111201	AA 050-02-10-01	PP/○	PP, self-venting	-	1250	MAH ○ MAQ ●	DMA ● DP ●
	111374	AA 050-02-10-03	PP/○	HDPE, solid piston	EPDM	1250	MAH ○ MAQ ●	DMA ● DP ●	
	116416	AA 050-02-30-01	PA/Ⓝ	PA, self-venting	-	1250	MAH ○ MAQ ●	DMA ● DP ●	
	154690	AA 050-02-10-33	PP/○	HDPE, self-venting	-	1250	MAH ○ MAQ ●	DMA ● DP ●	
	154644	AA 050-02-10-34	PP/○	HDPE, self-venting	EPDM	1250	MAH ○ MAQ ●	DMA ● DP ●	
	154691	AA 050-02-30-33	PA/○	HDPE, self-venting	-	1250	MAH ○ MAQ ●	DMA ● DP ●	
	4:1 50mL	116417	AA 050-04-10-01	PP/○	A-piston, PA, self-venting lip seal; B-piston, HDPE, solid piston with O-ring	EPDM	1250	MAHX ● MAQ ●	DMA ● DP ●
116676		AA 050-04-10-03	PP/○	HDPE, solid piston	EPDM	1250	MAHX ● MAQ ●	DMA ● DP ●	
116877		AA 050-04-30-02	PA/Ⓝ	A-piston, PA, self-venting lip seal; B-piston, PA, solid piston with O-ring	EPDM	1250	MAHX ● MAQ ●	DMA ● DP ●	
10:1 50mL	116418	AA 050-10-10-01	PP/○	A-piston, PP, self-venting lip seal; B-piston, HDPE, solid piston with O-ring	-	1250	MAHX ● MAQ ●	DMA ● DP ●	
	116419	AA 050-10-30-01	PA/Ⓝ	A-piston, PA, self-venting lip seal; B-piston, PA, solid piston with O-ring	-	1250	MAHX ● MAQ ●	DMA ● DP ●	
	116675	AA 050-10-10-02	PP/○	HDPE, solid piston	EPDM	1250	MAHX ● MAQ ●	DMA ● DP ●	
	116917	AA 050-10-10-03	PP/○	A-piston, PP, self-venting lip seal; B-piston, HDPE, solid piston with O-ring	EPDM	1250	MAHX ● MAQ ●	DMA ● DP ●	
	128166	AA 050-10-20-03	PBT/Ⓝ	A-piston, PA, self-venting lip seal; B-piston, PA, solid piston with O-ring	-	1250	MAHX ● MAQ ●	DMA ● DP ●	
	116915	AA 050-10-30-02	PA/○	A-piston, PA, self-venting lip seal; B-piston, PA, solid piston with O-ring	EPDM	1250	MAHX ● MAQ ●	DMA ● DP ●	

Matching mixers

	ID	Article	Number of Elements	Inner Diameter Ø mm/inch	Waste Volume (mL)	Units/Box	Outlet Tip				Accessories					
							Stepped Tip (T)	Straight Tip (D)	Luer Slip Tip (L)	Tapered Tip (S)	BRT 205-10	IOT 406-15	IOT 506-15	LA 05-00	LA 06-08	
1:1/2:1 MAH 	102361	MAH 03-07S	7	3.0/0.118	0.24	15000				✓						
	102362	MAH 03-13S	13	3.0/0.118	0.36	12000				✓						
	102364	MAH 03-17S	17	3.0/0.118	0.34	10000				✓						
	102366	MAH 04-13S	13	4.0/0.157	0.60	10000				✓						
	102367	MAH 04-17D	17	4.0/0.157	0.75	7000	✓				✓					
	102368	MAH 04-17S	17	4.0/0.157	0.75	7500				✓						
	102369	MAH 05-07T	7	5.4/0.213	0.80	10000	✓							✓		
	102370	MAH 05-13D	13	5.4/0.213	1.36	7000		✓			✓		✓			
	102371	MAH 05-13T	13	5.4/0.213	1.36	6500	✓							✓		
	102360	MAH 0517-0413T	17 +13	5.4/0.213 4.0/0.157	2.07	4000	✓									
	102372	MAH 05-17T	17	5.4/0.213	1.68	4000	✓							✓		
	102373	MAH 05-21T	21	5.4/0.213	2.01	3000	✓							✓		
	102377	MAH 06-12T	12	6.3/0.248	2.08	4500	✓									✓
	102378	MAH 06-17T	17	6.3/0.248	2.94	3000	✓									✓
	102379	MAH 06-21L	21	6.3/0.248	3.33	4000			✓							
102380	MAH 06-21T	21	6.3/0.248	3.57	2500	✓									✓	
4:1/10:1 MAHX 	102535	MAHX 04-17S	17	4.0/0.157	0.75	7500				✓						
	102536	MAHX 05-17T	17	5.4/0.213	1.68	4000	✓							✓		
1:1/2:1/4:1/10:1 MAQ  Color	300028	MAQ 05-16L	16	5.3/0.209	1.30	5000		✓								
	300026	MAQ 05-24L	24	5.3/0.209	1.90	3000		✓								
	300391	MAQ 05-16L-12	16	5.3/0.209	1.30	5000		✓								
	300405	MAQ 05-16L-13	16	5.3/0.209	1.30	5000		✓								

* different color

Matching dispensers

	ID	Article	Flange		Ratio				Force (kN)
			A		1:1	2:1	4:1	10:1	
DMA dispenser manual 	101875	DMA 51-00-10	✓		✓	✓			1.2
	101883	DMA 54-00-10	✓		✓	✓	✓		1.2
	112790	DMA 59-00-10	✓		✓	✓		✓	1.2
	111746	DMA 75-00-10	✓		✓				1.2
DP dispenser pneumatic 	151780	DP2 50-16-100	✓		✓	✓	✓	✓	1.6
	153098	DP2 75-16-100	✓		✓				1.6

MIXPAC™ B-System Overview

25/50/75mL Industrial Set

ACCESSORIES



Accessories

	ID	Article
	101651	BRT 205-10
	102274	IOT 406-15
	102277	IOT 506-15
	129178	IOT 715-50
	102356	LA 05-00
	102357	LA 06-08

Outlet Tip

-  Tapered Tip (S)
-  Straight Tip (D)
-  Luer Slip Tip (L)
-  Stepped Tip (T)

MIXER

-  ○ MBH (Helix)
-  ● MBQ (Quadro)

25mL

50mL

CARTRIDGE

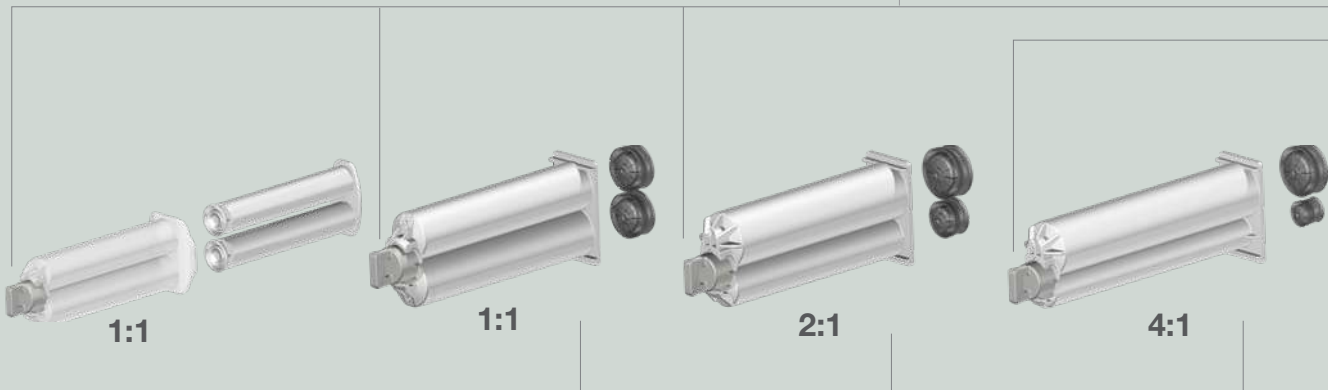

DISPENSER





Interface Converter

B-System => K-System

Ratio	ID	Article
1:1/2:1	128201	IBK 001-10
4:1/10:1	128202	IBKX 001-10



Interface Mixer

K-System

Ratio	Article
1:1/2:1	MKH
4:1/10:1	MKHX

=> for further information see K-System

Piston Retention Plate



Ratio	ID	Article
1:1/2:1	113719	PRS 050-01-02
4:1/10:1	116564	PRS 050-04-10A



- MBHX (Helix)
- MBQX (Quadro)

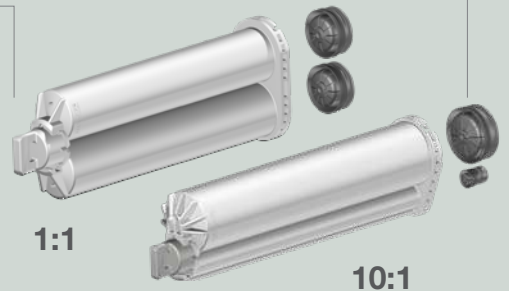
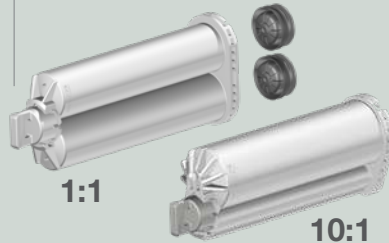
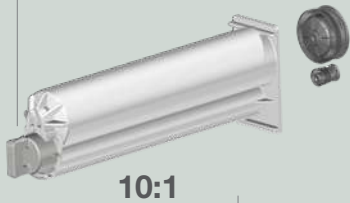

MIXPAC™ B-System Cartridge Set

25 Industrial Set Cartridge Assembly 25mL



Ratio Set/ Volume	ID	Article	Cartridges Material/Color	Plunger	Units/ Box	Mixer Technology
1:1 25mL	116647	AB 025-01-10-01	PP/ Ⓝ	Ⓝ	1000	MBH ○ MBQ ●
	116924	AB 025-01-10-02	PP/ Ⓝ	●	1000	MBH ○ MBQ ●
	116926	AB 025-01-10-05	PP/ Ⓝ	●	1000	MBH ○ MBQ ●
	116927	AB 025-01-10-07	PP/ ●	●	1000	MBH ○ MBQ ●
	128982	AB 025-01-10-08	PP/ ●	●	1000	MBH ○ MBQ ●
	116649	AB 025-01-30-01	PA/ Ⓝ	Ⓝ	1000	MBH ○ MBQ ●
	116923	AB 025-01-30-07	PA/ ●	●	1000	MBH ○ MBQ ●
	129377	AB 025-01-30-09	PA/ ●	●	1000	MBH ○ MBQ ●

Matching mixers

	ID	Article	Number of Elements	Inner Diameter Ø mm/inch	Waste Volume (mL)	Units/ Box	Outlet Tip				Accessories							
							Stepped Tip (T)	Straight Tip (D)	Luer Slip Tip (L)	Tapered Tip (S)	LA 05-00	LA 06-08	BRT 205-10	IOT 406-15	IOT 506-15	IOT 715-50		
1:1 MBH	116457	MBH 03-12D	12	3.2/0.126	0.49	8000	✓										✓	
	116458	MBH 03-12S	12	3.2/0.126	0.49	8000			✓									
	116459	MBH 03-16D	16	3.2/0.126	0.63	8000	✓											✓
	116460	MBH 03-16L	16	3.2/0.126	0.63	7000			✓									
	116461	MBH 03-16S	16	3.2/0.126	0.59	8000				✓								
	116462	MBH 04-12D	12	4.2/0.165	0.84	7000	✓											✓
	116463	MBH 04-16D	16	4.2/0.165	1.04	5000	✓											✓
	116464	MBH 04-16S	16	4.2/0.165	1.04	5000				✓								
	116575	MBH 05-06T	6	5.4/0.213	0.94	8000	✓				✓							
	116465	MBH 05-12D	12	5.4/0.213	1.52	5000		✓					✓					✓
	116466	MBH 05-14D	14	5.4/0.213	1.91	4000		✓					✓					✓
	116467	MBH 05-16T	16	5.4/0.213	1.91	4000	✓				✓							
	116468	MBH 05-20T	20	5.4/0.213	2.92	3000	✓				✓							
	116469	MBH 06-11D	11	6.5/0.256	2.28	4000		✓					✓					✓
	116470	MBH 06-16T	16	6.5/0.256	3.14	3000	✓					✓						
	116471	MBH 06-20T	20	6.5/0.256	3.76	2000	✓					✓						
	116472	MBH 07-11D	11	7.5/0.295	3.05	4000		✓										✓
	1:1 MBQ	114144	MBQ 05-16L	16	5.3/0.209	1.88	3000			✓								
114145		MBQ 05-24L	24	5.3/0.209	2.60	3000				✓								



MIXPAC™ B-System Cartridge Set

50/75 Industrial Set Cartridge Assembly 50/75mL

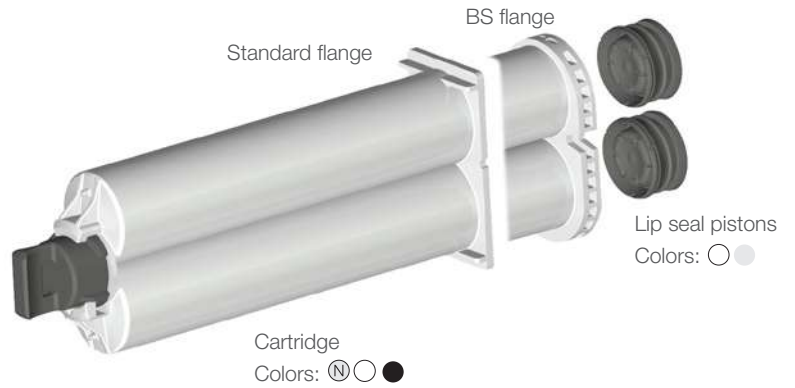

Ratio Set/ Volume	ID	Article	Cartridges Material/ Color	Piston Type/ Material	O-ring	Units/ Box	Mixer Technology	Matching Dispenser
1:1 50mL	112511	AB 050-01-10-01	PP/ ○	PP, self-venting	-	1250	MBH ○ MBQ ●	DMA ● DP ●
	116347	AB 050-01-10-02	PP/ ○	PP, self-venting	EPDM	1250	MBH ○ MBQ ●	DMA ● DP ●
	128082	AB 050-01-10-05	PP/ ○	PP, self-venting	Silicone	1250	MBH ○ MBQ ●	DMA ● DP ●
	154853	AB 050-01-10-33	PP/ ○	HDPE, self-venting	-	1250	MBH ○ MBQ ●	DMA ● DP ●
	154825	AB 050-01-10-34	PP/ ○	HDPE, self-venting	EPDM	1250	MBH ○ MBQ ●	DMA ● DP ●
	154854	AB 050-01-10-37	PP/ ●	HDPE, self-venting	-	1250	MBH ○ MBQ ●	DMA ● DP ●
	117031	AB 050-01-20-01	PBT/ ⊗	PA, self-venting	-	1250	MBH ○ MBQ ●	DMA ● DP ●
	128335	AB 050-01-20-02	PBT/ ⊗	PA, self-venting	EPDM	1250	MBH ○ MBQ ●	DMA ● DP ●
	154855	AB 050-01-20-33	PBT/ ⊗	HDPE, self-venting	-	1250	MBH ○ MBQ ●	DMA ● DP ●
	154824	AB 050-01-20-34	PBT/ ⊗	HDPE, self-venting	EPDM	1250	MBH ○ MBQ ●	DMA ● DP ●
	154857	AB 050-01-30-33	PA/ ○	HDPE, self-venting	-	1250	MBH ○ MBQ ●	DMA ● DP ●
	154485	AB 050-01-30-34	PA/ ○	HDPE, self-venting	EDPM	1250	MBH ○ MBQ ●	DMA ● DP ●
	154851	AB 050-01-30-37	PA/ ●	HDPE, self-venting	-	1250	MBH ○ MBQ ●	DMA ● DP ●
	2:1	114099	AB 050-02-10-01	PP/ ○	PP, self-venting	-	1250	MBH ○ MBQ ●
116342		AB 050-02-10-02	PP/ ○	PP, self-venting	EPDM	1250	MBH ○ MBQ ●	DMA ● DP ●
154645		AB 050-02-10-33	PP/ ○	HDPE, self-venting	-	1250	MBH ○ MBQ ●	DMA ● DP ●
154646		AB 050-02-10-34	PA/ ○	HDPE, self-venting	EPDM	1250	MBH ○ MBQ ●	DMA ● DP ●
116354		AB 050-02-30-01	PA/ ○	PA, self-venting	-	1250	MBH ○ MBQ ●	DMA ● DP ●
116356		AB 050-02-30-02	PA/ ○	PA, self-venting	EPDM	1250	MBH ○ MBQ ●	DMA ● DP ●
128346		AB 050-02-30-03	PA/ ⊗	PA, self-venting	-	1250	MBH ○ MBQ ●	DMA ● DP ●
154676		AB 050-02-30-33	PP/ ○	HDPE, self-venting	-	1250	MBH ○ MBQ ●	DMA ● DP ●
154705		AB 050-02-30-34	PA/ ○	HDPE, self-venting	EPDM	1250	MBH ○ MBQ ●	DMA ● DP ●
154707		AB 050-02-30-35	PA/ ⊗	HDPE, self-venting	-	1250	MBH ○ MBQ ●	DMA ● DP ●
4:1 50mL	116421	AB 050-04-10-01	PP/ ○	A-piston, PP, self-venting lip seal; B-piston, PP, solid lip seal	-	625	MBHX ● MBQX ●	DMB ● DP ●
	128606	AB 050-04-10-02	PP/ ○	A-piston, PP, self-venting lip seal; B-piston, PP, solid lip seal with O-ring	EPDM	625	MBHX ● MBQX ●	DMB ● DP ●
	116422	AB 050-04-20-01	PBT/ ⊗	A-piston, PA, self-venting lip seal; B-piston, PA, solid lip seal	-	625	MBHX ● MBQX ●	DMB ● DP ●
10:1 50mL	116423	AB 050-10-10-01	PP/ ○	A-piston, PP, self-venting lip seal; B-piston, PP, solid lip seal	-	625	MBHX ● MBQX ●	DMB ● DP ●
	151982	AB 050-10-10-02	PP/ ○	A-piston, PA, self-venting lip seal; B-piston, HDPE, solid piston with O-ring	EDPM	625	MBHX ● MBQX ●	DMB ● DP ●
	116424	AB 050-10-20-01	PBT/ ⊗	A-piston, PA, self-venting lip seal; B-piston, PA, solid lip seal	-	625	MBHX ● MBQX ●	DMB ● DP ●

BS flange



Ratio Set/ Volume	ID	Article	Cartridges Material/ Color	Piston Type/ Material	O-ring	Units/ Box	Mixer Technology	Matching Dispenser
1:1 50mL	154850	AB S50-01-10-33	PP/ ○	HDPE, self-venting	-	1250	MBH ● MBQ ○	DS ● DP ●
	154829	AB S50-01-10-37	PP/ ●	HDPE, self-venting	-	1250	MBHX ● MBQX ●	DS ● DP ●
	154828	AB S50-01-30-33	PA/ ○	HDPE, self-venting	-	1250	MBH ● MBQ ○	DS ● DP ●
75mL	128619	AB S75-01-10-01	PP/ ⊗	PP, self-venting	-	625	MBHX ● MBQX ●	DS ● DP ●
	158029	AB S75-01-10-33	PP/ ⊗	HDPE, self-venting	-	625	MBHX ● MBQX ●	DS ● DP ●
2:1 50mL	154708	AB S50-02-10-33	PP/ ○	HDPE, self-venting	-	1250	MBHX ● MBQX ●	DS ● DP ●
10:1 50mL	152458	AB S50-10-10-01	PP/ ○	PP, self-venting	-	625	MBHX ● MBQX ●	DS ● DP ●
	116373	AB S50-10-20-01	PBT/ ⊗	PA, self-venting	-	1250	MBHX ● MBQX ●	DS ● DP ●
	116805	AB S50-10-20-06	PBT/ ⊗	PA, solid lip seal with O-ring	Silicone	1250	MBHX ● MBQX ●	DS ● DP ●
	152397	AB S50-10-20-08	PBT/ ⊗	A-piston, PA, self-venting lip seal B-piston, PA, solid lip seal with O-ring	Silicone	1250	MBHX ● MBQX ●	DS ● DP ●
10:1 75mL	116449	AB S75-10-20-02	PBT/ ⊗	PA, solid lip seal with O-ring	Silicone	900	MBHX ● MBQX ●	DS ● DP ●
	116305	AB S75-10-20-03	PBT/ ⊗	PA, solid lip seal with O-ring	Silicone	350	MBHX ● MBQX ●	DS ● DP ●
	154086	AB S75-10-20-05	PBT/ ⊗	A-piston, PA, self-venting lip seal B-piston, PA, self-venting lip seal with O-ring	Silicone	900	MBHX ● MBQX ●	DS ● DP ●

Matching mixers

	ID	Article	Number of Elements	Inner Diameter Ø mm/inch	Waste Volume (mL)	Units/ Box	Outlet Tip				Accessories				
							Stepped Tip (T)	Straight Tip (D)	Luer Slip Tip (L)	Tapered Tip (S)	LA 05-00	LA 06-08	BRT 205-10	IOT 406-15	IOT 506-15
1:1/2:1 MBH	116457	MBH 03-12D	12	3.2/0.126	0.49	8000	✓						✓	✓	✓
	116458	MBH 03-12S	12	3.2/0.126	0.49	8000			✓						
	116459	MBH 03-16D	16	3.2/0.126	0.63	8000	✓					✓	✓	✓	
	116460	MBH 03-16L	16	3.2/0.126	0.63	7000		✓							
	116461	MBH 03-16S	16	3.2/0.126	0.59	8000			✓						
	 116462	MBH 04-12D	12	4.2/0.165	0.84	7000	✓					✓			
	116463	MBH 04-16D	16	4.2/0.165	1.04	5000	✓					✓			
	116464	MBH 04-16S	16	4.2/0.165	1.04	5000			✓						
	116575	MBH 05-06T	6	5.4/0.213	0.94	8000	✓			✓					
	116465	MBH 05-12D	12	5.4/0.213	1.52	5000	✓					✓	✓		
	116466	MBH 05-14D	14	5.4/0.213	1.91	4000	✓					✓	✓		
	116467	MBH 05-16T	16	5.4/0.213	1.91	4000	✓			✓					
	116468	MBH 05-20T	20	5.4/0.213	2.29	3000	✓			✓					
	116469	MBH 06-11D	11	6.5/0.256	2.28	4000		✓				✓	✓		
	116470	MBH 06-16T	16	6.5/0.256	3.14	3000	✓				✓				
	116471	MBH 06-20T	20	6.5/0.256	3.76	2000	✓				✓				✓
116472	MBH 07-11D	11	7.5/0.295	3.05	4000		✓								
4:1/10:1 MBHX	116473	MBHX 03-16S	16	3.2/0.126	0.60	7000			✓						
	116474	MBHX 04-16D	16	4.2/0.165	1.05	6000	✓					✓			
	116576	MBHX 04-16S	16	4.2/0.165	1.05	5000			✓						
	116475	MBHX 05-12D	12	5.4/0.213	1.52	5000	✓					✓	✓	✓	
	116476	MBHX 05-16T	16	5.4/0.213	1.91	4000	✓			✓					
	116477	MBHX 05-20T	20	5.4/0.213	2.07	3000	✓			✓					
	116478	MBHX 06-16D	16	6.5/0.256	3.14	3000	✓				✓				
116480	MBHX 06-16T	16	6.5/0.256	3.04	3000	✓					✓	✓			
116481	MBHX 06-20T	20	6.5/0.256	3.79	2000	✓				✓					
1:1/2:1 MBQ	114144	MBQ 05-16L	16	5.3/0.209	1.88	3000			✓						
	154801	MBQ 05-16L-12 ●*	16	5.3/0.209	1.88	3000			✓						
	114145	MBQ 05-24L	24	5.3/0.209	2.60	3000			✓						
4:1/10:1 MBQX	116063	MBQX 05-16L	16	5.3/0.209	1.72	3000			✓						
	116062	MBQX 05-24L	24	5.3/0.209	2.37	3000			✓						

* different color

Matching dispensers

	ID	Article	Flange		Ratio				Force (kN)
			B 50	B S50	1:1	2:1	4:1	10:1	
DMA/DMB dispenser manual 	101875	DMA 51-00-10	✓		✓	✓			1.2
	116795	DMB 50-04-01	✓				✓		1.2
	116794	DMB 50-10-01	✓					✓	1.2
DS dispenser manual 	101934	DS 53-01-00		✓	✓	✓			1.2
	109146	DS 51-04-00		✓			✓		1.2
	101929	DS 51-10-00		✓				✓	1.2
	115676	DS 75-10-00		✓				✓	1.2
	110938	DS 77-01-00		✓	✓				1.2
DP dispenser pneumatic 	151780	DP2 50-16-100	✓		✓	✓			1.6
	153094	DP2 50-16-400	✓				✓	✓	1.6
	151886	DP2 50-16-300		✓				✓	1.6
	151781	DP2 50-16-200		✓	✓	✓			1.6

A person wearing a grey knitted sweater is using a Sulzer MIXPAC C-System adhesive dispenser. The dispenser is a grey and black tool with a white cartridge containing adhesive. The person is applying the adhesive to a white ceramic toilet component that is held in a metal clamp on a workbench. The workbench is covered with a dark grey mat. In the background, there is a white plastic chair and a white bucket. The text "Introducing Sulzer MIXPAC™ C-Systems" is overlaid on the image in white font.

Introducing
Sulzer MIXPAC™
C-Systems

MIXPAC™ C-System Overview 200/400mL Industrial Set

ACCESSORIES

Accessories

	ID	Article
	103663	TA 10-ET
	103664	TC 10-ET
	101656 101657	BSD 10-25 BSD 10-40
	300326	BSDQ 08-38
	102357 102358	LA 06-08 LA 10-00

Outlet Tip

-  Tapered Tip (S)
-  Straight Tip (D)
-  Luer Slip Tip (L)
-  Stepped Tip (T)

MIXER

-  ○ MGH (Helix)
-  ○ MCH (Helix)
-  ● MCQ (Quadro)
-  ● MGQ (Quadro)

200mL

CARTRIDGE

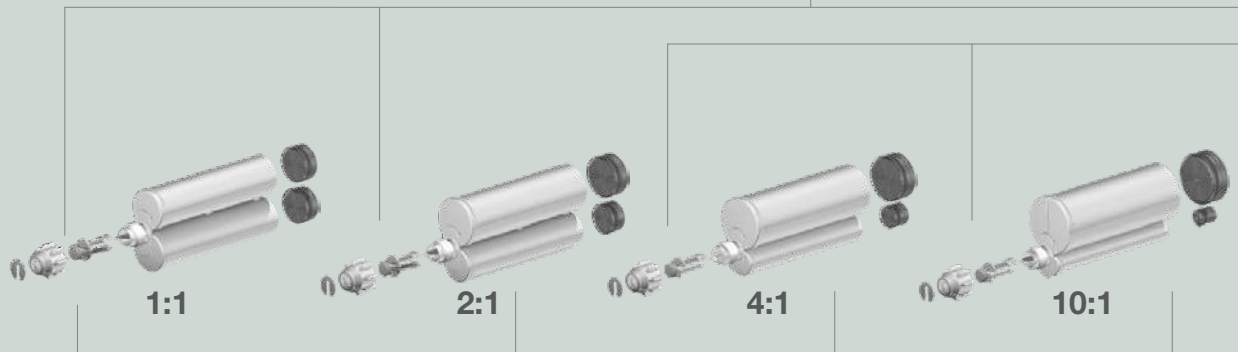

DISPENSER



- MGH (Helix)
- MGQ (Quadro)
- MCHX (Helix)

400mL



1:1



2:1



4:1



10:1



● DB



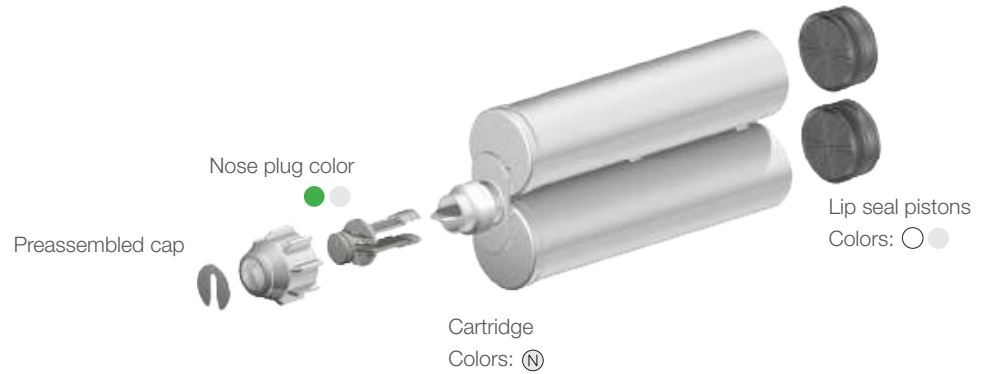

MIXPAC™ C-System Cartridge Set

200/400 Industrial Set Cartridge Assembly 200/400mL





Ratio Set/ Volume	ID	Article	Cartridges Material/ Color	Pistons Material	O-ring	Units/ Box	Mixer Technology	Matching Dispenser
1:1 200mL	112158	AC 200-01-10-01	PP/ (N)	PP, self-venting	-	300	MCH ○ MCQ ● MGH ○ MGQ ●	DM ● DP ●
	128249	AC 200-01-10-02	PP/ (N)	PP, self-venting	-	300	MCH ○ MCQ ● MGH ○ MGQ ●	DM ● DP ●
	116338	AC 200-01-10-03	PP/ (N)	PP, self-venting	-	300	MCH ○ MCQ ● MGH ○ MGQ ●	DM ● DP ●
	116410	AC 200-01-10-04	PP/ (N)	PP, self-venting	-	300	MCH ○ MCQ ● MGH ○ MGQ ●	DM ● DP ●
	116578	AC 200-01-10-05	PP/ (N)	PP, self-venting	-	300	MCH ○ MCQ ● MGH ○ MGQ ●	DM ● DP ●
	112698	AC 200-01-30-01	PA/ (N)	PA, self-venting	-	300	MCH ○ MCQ ● MGH ○ MGQ ●	DM ● DP ●
	127920	AC 200-01-30-04	PA/ (N)	PA, self-venting	-	300	MCH ○ MCQ ● MGH ○ MGQ ●	DM ● DP ●
1:1 400mL	103721	AC 400-01-10-01	PP/ (N)	PP, self-venting	-	180	MCH ○ MCQ ● MGH ○ MGQ ●	DM ● DP ●
	113209	AC 400-01-10-02	PP/ (N)	PP, self-venting	-	180	MCH ○ MCQ ● MGH ○ MGQ ●	DM ● DP ●
	116317	AC 400-01-10-04	PP/ (N)	PP, self-venting	-	180	MCH ○ MCQ ● MGH ○ MGQ ●	DM ● DP ●
	115455	AC 400-01-10-05	PP/ (N)	PP, self-venting	-	180	MCH ○ MCQ ● MGH ○ MGQ ●	DM ● DP ●
	112702	AC 400-01-30-01	PA/ (N)	PA, self-venting	-	180	MCH ○ MCQ ● MGH ○ MGQ ●	DM ● DP ●
	116412	AC 400-01-30-04	PA/ (N)	PA, self-venting	-	180	MCH ○ MCQ ● MGH ○ MGQ ●	DM ● DP ●
2:1 200mL	112699	AC 200-02-10-01	PP/ (N)	PP, self-venting	-	280	MCH ○ MCQ ● MGH ○ MGQ ●	DM ● DP ●
	129165	AC 200-02-10-05	PP/ (N)	PP, self-venting	-	280	MCH ○ MCQ ● MGH ○ MGQ ●	DM ● DP ●
2:1 400mL	108663	AC 400-02-10-01	PP/ (N)	PP, self-venting	-	175	MCH ○ MCQ ● MGH ○ MGQ ●	DM ● DP ●
	116318	AC 400-02-10-04	PP/ (N)	PP, self-venting	-	175	MCH ○ MCQ ● MGH ○ MGQ ●	DM ● DP ●
	129156	AC 400-02-10-05	PP/ (N)	PP, self-venting	-	175	MCH ○ MCQ ● MGH ○ MGQ ●	DM ● DP ●
4:1 200mL	127894	AC 200-04-10-04	PP/ (N)	PP, self-venting	-	265	MCH ○ MCQ ● MGH ○ MGQ ●	DM ● DP ●
4:1 400mL	112530	AC 400-04-10-01	PP/ (N)	PP, self-venting	-	170	MCHX ● MGH ○ MGQ ●	DM ● DP ●
	115454	AC 400-04-10-05	PP/ (N)	PP, self-venting	-	170	MCHX ● MGH ○ MGQ ●	DM ● DP ●
	115454	AC 400-04-10-05	PP/ (N)	PP, self-venting	-	170	MCHX ● MGH ○ MGQ ●	DM ● DP ●
	116413	AC 400-04-10-04	PP/ (N)	PP, self-venting	-	170	MCHX ● MGH ○ MGQ ●	DM ● DP ●
	128441	AC 400-04-10-06	PP/ (N)	PP, self-venting	-	170	MCHX ● MGH ○ MGQ ●	DM ● DP ●
10:1 200mL	112468	AC 200-10-10-01	PP/ (N)	PP, self-venting	-	250	MCHX ● MGH ○ MGQ ●	DM ● DP ●
	108397	AC 200-10-10-02	PP/ (N)	PP, self-venting	-	250	MCHX ● MGH ○ MGQ ●	DM ● DP ●
	116532	AC 200-10-10-03	PP/ (N)	PP, self-venting	-	250	MCHX ● MGH ○ MGQ ●	DM ● DP ●
	127919	AC 200-10-10-04	PP/ (N)	PP, self-venting	-	250	MCHX ● MGH ○ MGQ ●	DM ● DP ●
	114307	AC 200-10-30-01	PA/ (N)	PA, self-venting	-	250	MCHX ● MGH ○ MGQ ●	DM ● DP ●
10:1 400mL	112622	AC 400-10-10-01	PP/ (N)	PP, self-venting	-	165	MCHX ● MGH ○ MGQ ●	DM ● DP ● DB ●
	116580	AC 400-10-10-04	PP/ (N)	PP, self-venting	-	165	MCHX ● MGH ○ MGQ ●	DM ● DP ● DB ●
	113820	AC 400-10-10-06	PP/ (N)	PP, self-venting	-	165	MCHX ● MGH ○ MGQ ●	DM ● DP ● DB ●
	113615	AC 400-10-10-05	PP/ (N)	PP, self-venting	-	165	MCHX ● MGH ○ MGQ ●	DM ● DP ● DB ●

Matching mixers

	ID	Article	Number of Elements	Inner Diameter Ø mm/inch	Waste Volume (mL)	Units/Box	Outlet Tip				Accessories							
							Stepped Tip (T)	Straight Tip (D)	Luer Slip Tip (L)	Tapered Tip (S)	BSD 10-25	BSD 10-40	LA 05-00	LA 06-08	LA 10-00	BSDQ 08-38	TA 10-ET	TC 10-ET
1:1/2:1 MCH 	102414	MCH 05-18T	18	5.0/0.197	2.10	3000	✓					✓						
	102415	MCH 05-24T	24	5.0/0.197	2.00	2000	✓					✓						
	102416	MCH 05-32T	32	5.0/0.197	2.60	2000	✓					✓						
	102417	MCH 06-18T	18	6.0/0.236	3.60	2000	✓						✓					
	102418	MCH 06-24T	24	6.0/0.236	4.20	2000	✓						✓					
	102419	MCH 06-32T	32	6.0/0.236	5.00	1700	✓						✓					
	102421	MCH 08-18T	18	8.0/0.315	6.70	2000	✓						✓					
	102424	MCH 08-24T	24	8.0/0.315	8.50	1500	✓						✓					
	102425	MCH 08-32T	32	8.0/0.315	10.90	1200	✓						✓					
	102427	MCH 1008-18S	18	8.0/0.315	10.20	1000				✓								
	102429	MCH 10-18T	18	10.0/0.394	12.30	1400	✓							✓				
	102430	MCH 10-20D	20	10.0/0.394	12.60	1200		✓			✓	✓					✓	✓
	102432	MCH 10-24D	24	10.0/0.394	15.30	1000		✓			✓	✓					✓	✓
	102431	MCH 10-24T	24	10.0/0.394	14.60	1000	✓							✓				
	102433	MCH 10-32T	32	10.0/0.394	17.70	900	✓							✓				
	102434	MCH 13-12T	13	10.0/0.394	14.70	1400	✓											
	102435	MCH 13-18T	18	13.0/0.512	21.00	1000	✓											
	102437	MCH 13-24T	24	13.0/0.512	27.30	800	✓											
	102438	MCH 13-32T	32	13.0/0.512	25.70	600	✓											
4:1/10:1 MCHX 	102440	MCHX 08-18T	18	8.0/0.315	6.40	1800	✓						✓					
	102443	MCHX 08-24T	24	8.0/0.315	9.30	1500	✓						✓					
	102444	MCHX 10-12T	12	10.0/0.394	9.60	2000	✓							✓				
	102445	MCHX 10-18T	18	10.0/0.394	11.90	1400	✓							✓				
	102446	MCHX 10-24T	24	10.0/0.394	16.20	1000	✓							✓				
	112498	MCHX 13-12-30	12	15.0/591	27.00	1000	✓											
1:1/2:1 MCQ 	300002	MCQ 05-24L	24	5.3/207	3.46	1500			✓									
	300006	MCQ 07-24T	24	7.5/295	6.19	1000	✓											
	300455	MCQ 08-24T	24	8.7/0.343	8.44	1300	✓								✓			
	300375	MCQ 08-32T	32	8.7/0.343	10.37	900	✓								✓			
	300496	MCQ 10-24T-01	24	10.7/0.421	14.04	800	✓											
	300377	MCQ 10-32T	32	10.7/0.421	18.45	600	✓											
1:1/2:1/4:1/10:1 MGH 	102480	MGH 08-06S	6	8.0/0.315	3.67	1500				✓								
1:1/2:1/4:1/10:1 MGQ 	300469	MGQ 08-18T	18	8.7/0.343	6.70	1200	✓								✓			
	300454	MGQ 08-20D	20	8.7/0.343	7.57	1000		✓										
	300453	MGQ 08-20T	20	8.7/0.343	7.34	1000	✓								✓			
	300462	MGQ 08-24D	24	8.7/0.343	8.61	800		✓										
	300461	MGQ 08-24T	24	8.7/0.343	8.76	800	✓								✓			
	300493	MGQ 10-19D	19	10.7/0.421	12.15	800		✓										
	300497	MGQ 10-24D	24	10.7/0.421	14.49	650		✓										

Matching dispensers

	ID	Article	Volume mL		Ratio				Force (kN)
			200	400	1:1	2:1	4:1	10:1	
DM dispenser manual 	114413	DM 200-01	✓		✓	✓			5.2
	114425	DM 200-04	✓				✓		5.2
	114535	DM 200-10	✓					✓	5.2
	114399	DM 400-01		✓	✓	✓			6.4
	114400	DM 400-04		✓			✓		6.4
	114401	DM 400-10		✓				✓	6.4
	DP dispenser pneumatic 	114780	DP 200-70-01	✓		✓	✓		
114664		DP 200-70-04	✓				✓		2.2
114539		DP 200-70-10	✓					✓	2.2
114781		DP 400-85-01		✓	✓	✓			3.2
114782		DP 400-85-04		✓			✓		3.2
114783		DP 400-85-10		✓				✓	3.2
114466		DP 400-100-01		✓	✓	✓			4.5
114559		DP 400-100-04		✓			✓		4.5
114465		DP 400-100-10		✓				✓	4.5
DB dispenser battery 	152603	DB2 400-50-100		✓	✓				5.0
	152605	DB2 400-50-200		✓		✓			5.0
	152607	DB2 400-50-300		✓			✓		5.0
	152609	DB2 400-50-400		✓				✓	5.0



Introducing
Sulzer MIXPAC™
F-Systems

MIXPAC™ F-System Overview 200/400mL Industrial Set

ACCESSORIES

Accessories

	ID	Article
	103663	TA 10-ET
	103664	TC 10-ET
	124698 119620 101656 101657 116166	BSD 08-25 BSD 08-40 BSD 10-25 BSD 10-40 BSD 13-50
	300326	BSDQ 08-38
	102357 102358	LA 06-08 LA 10-00

Outlet Tip

-  Straight Tip (D)
-  Luer Slip Tip (L)
-  Stepped Tip (T)

MIXER

-  ○ MFH (Helix)
-  ● MFQ (Quadro)

200mL

CARTRIDGE

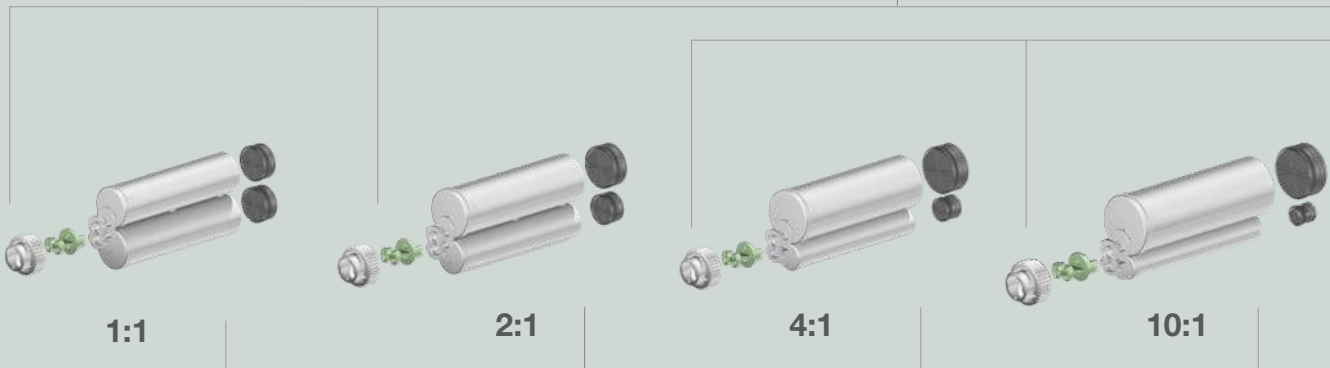

DISPENSER



Interface Converter

F-System => B-System

Ratio	ID	Article
1:1/2:1	116803	IFB 001-10
4:1/10:1	116804	IFBX 001-10

Interface Mixer

B-System

Ratio	Article
1:1/2:1	MBH
4:1/10:1	MBHX

=> for further information see B-System

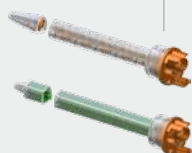

● MFHX (Helix)

● MFQX (Quadro)

400mL

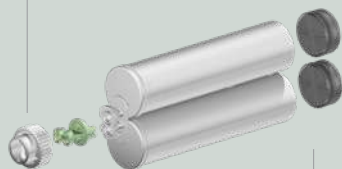

1:1

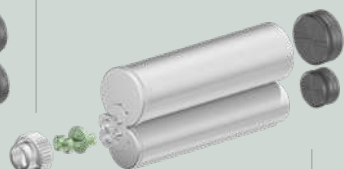

2:1

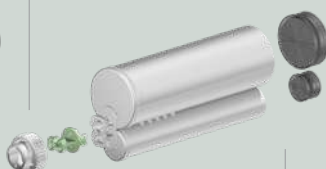

4:1



10:1



● DB

MIXPAC™ F-System Cartridge Set

200 Industrial Set

Cartridge Assembly 210-250mL

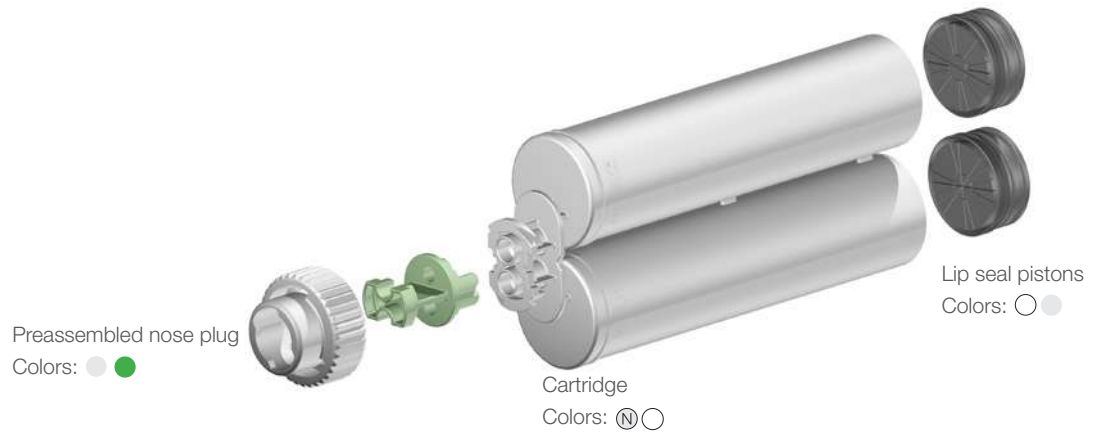

Ratio Set/ Volume	ID	Article	Cartridges Material/Color	Lip seal pistons Material	O-ring	Units/ Box	Mixer Technology	Matching Dispenser
1:1 200mL	112390	AF 200-01-10-01	PP/ (N)	PP, self-venting	-	300	MFH ○ MFQ ○	DM ● DP ●
	128960	AF 200-01-10-05	PP/ (N)	PP, self-venting	-	300	MFH ○ MFQ ○	DM ● DP ●
	112391	AF 200-01-30-01	PA/ (N)	PA, self-venting	-	300	MFH ○ MFQ ○	DM ● DP ●
2:1 200mL	112398	AF 200-02-10-01	PP/ (N)	PP, self-venting	-	280	MFH ○ MFQ ○	DM ● DP ●
	128607	AF 200-02-10-02	PP/ (N)	PP, self-venting	-	280	MFH ○ MFQ ○	DM ● DP ●
	151831	AF 200-02-10-05	PP/ (N)	PP, self-venting	-	280	MFH ○ MFQ ○	DM ● DP ●
	112400	AF 200-02-30-01	PA/ (N)	PA, self-venting	-	280	MFH ○ MFQ ○	DM ● DP ●
	116699	AF 200-02-30-05	PA/ (N)	PA, self-venting	-	280	MFH ○ MFQ ○	DM ● DP ●
4:1 200mL	112393	AF 200-04-10-01	PP/ (N)	PP, self-venting	-	265	MFHX ● MFQX ●	DM ● DP ●
10:1 200mL	112402	AF 200-10-10-01	PP/ (N)	PP, self-venting	-	250	MFHX ● MFQX ●	DM ● DP ●
	128961	AF 200-10-10-05	PP/ (N)	PP, self-venting	-	250	MFHX ● MFQX ●	DM ● DP ●
	116053	AF 200-10-20-01	PBT/ (N)	PA, self-venting	-	250	MFHX ● MFQX ●	DM ● DP ●
	116643	AF 200-10-20-05	PBT/ (N)	PA, self-venting	-	250	MFHX ● MFQX ●	DM ● DP ●

Matching mixers

	ID	Article	Number of Elements	Inner Diameter Ø mm/inch	Waste Volume (mL)	Units/Box	Outlet Tip			Accessories									
							Stepped Tip (T)	Straight Tip (D)	Luer Slip Tip (L)	TA 10-ET	TC 10-ET	LA 06-08	LA 10-00	BSD-08-50	BSD-10-25	BSD-10-40	BSD-13-50	BSDQ-08-38	
1:1/2:1 MFH	102466	MFH 06-18T	18	6.0/0.236	4.36	1700	✓				✓								
	102467	MFH 06-24T	24	6.0/0.236	5.40	1400	✓				✓								
	116040	MFH 06-32T	32	6.0/0.236	6.65	700	✓				✓								
	102468	MFH 08-18T	18	8.0/0.315	7.40	1400	✓				✓		✓						
	102469	MFH 08-24T	24	8.0/0.315	9.30	1200	✓				✓		✓						
	102470	MFH 08-32T	32	8.0/0.315	11.85	900	✓				✓		✓						
	102471	MFH 10-18T	18	10.0/0.394	13.09	1000	✓			✓	✓		✓		✓	✓			
	102472	MFH 10-24T	24	10.0/0.394	16.89	900	✓			✓	✓		✓		✓	✓			
	110583	MFH 10-32T	32	10.0/0.394	21.94	500	✓			✓	✓		✓		✓	✓			
	151603	MFH 13-18T	18	13.0/0.512	20.56	800	✓											✓	
	151604	MFH 13-24T	24	13.0/0.512	26.31	600	✓											✓	
	4:1/10:1 MFHX	102473	MFHX 06-18T	18	6.0/0.236	4.16	1700	✓				✓							
		102474	MFHX 06-24T	24	6.0/0.236	5.20	1400	✓				✓							
		113275	MFHX 06-32T	32	6.0/0.236	6.56	1200	✓				✓							
		102475	MFHX 08-18T	18	8.0/0.315	7.28	1400	✓				✓		✓					
102476		MFHX 08-24T	24	8.0/0.315	9.14	1200	✓				✓		✓						
112720		MFHX 08-32T	32	8.0/0.315	11.55	900	✓				✓		✓						
102477		MFHX 10-18T	18	10.0/0.394	12.96	1000	✓			✓	✓		✓		✓	✓			
102478		MFHX 10-24T	24	10.0/0.394	16.70	900	✓			✓	✓		✓		✓	✓			
113250		MFHX 10-32T	32	10.0/0.394	21.22	500	✓			✓	✓		✓		✓	✓			
151605		MFHX 13-18T	18	13.0/0.512	20.73	800	✓											✓	
151606		MFHX 13-24T	24	13.0/0.512	26.48	600	✓											✓	
1:1/2:1 MFQ		116032	MFQ 05-16L	16	5.3/0.209	2.90	2500		✓										
	116033	MFQ 05-24L	24	5.3/0.209	3.52	2000		✓											
	116034	MFQ 07-24T	24	7.5/0.295	6.11	1500	✓												
	115959	MFQ 08-24T	24	8.7/0.343	8.69	750	✓											✓	
	116734	MFQ 08-32D	32	8.7/0.343	11.10	800		✓											
	116035	MFQ 10-24T	24	10.7/0.421	14.75	600	✓												
	4:1/10:1 MFQX	116036	MFQX 05-16L	16	5.3/0.209	3.07	2500		✓										
116037		MFQX 05-24L	24	5.3/0.209	3.69	2000		✓											
116038		MFQX 07-24T	24	7.5/0.295	6.28	1500	✓												
116039		MFQX 08-24T	24	8.7/0.343	8.86	750	✓											✓	
116735		MFQX 08-32D	32	8.7/0.343	11.10	800		✓											
116044		MFQX 10-24T	24	10.7/0.421	14.92	600	✓												

Matching dispensers

	ID	Article	Ratio				Force (kN)
			1:1	2:1	4:1	10:1	
DM dispenser manual	114413	DM 200-01	✓	✓			5.2
	114425	DM 200-04			✓		5.2
	114535	DM 200-10				✓	5.2
DP dispenser pneumatic	114780	DP 200-70-01	✓	✓			2.2
	114664	DP 200-70-04			✓		2.2
	114539	DP 200-70-10				✓	2.2

MIXPAC™ F-System Cartridge Set

400 Industrial Set

Cartridge Assembly 400-490mL

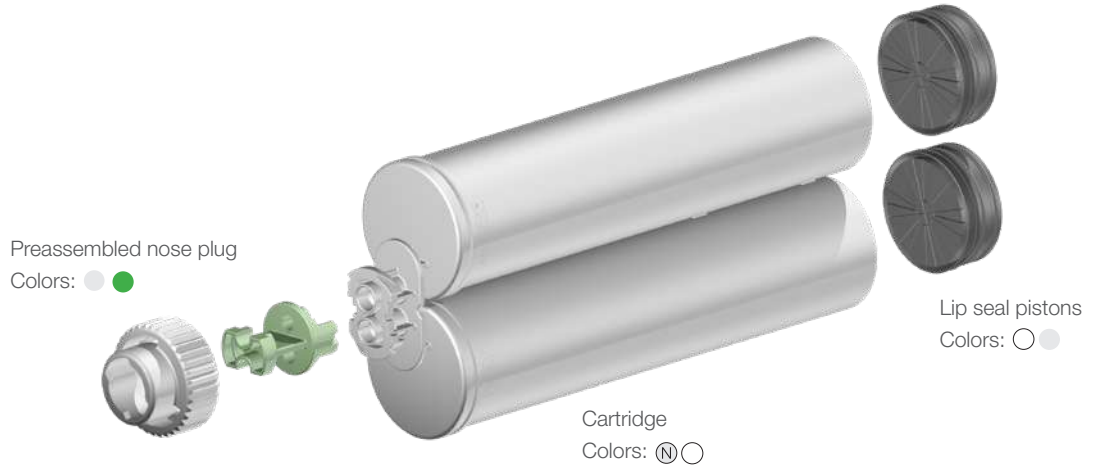



Ratio Set/ Volume	ID	Article	Cartridges Material/Color	Lip seal pistons Material	O-ring	Units/ Box	Mixer Technology	Matching Dispenser
1:1 400mL	112410	AF 400-01-10-01	PP/ ○	PP, self-venting	-	180	MFH ○ MFQ ○	DM ● DP ● DB ●
	117111	AF 400-01-10-02	PP/ ○	PP, self-venting	-	180	MFH ○ MFQ ○	DM ● DP ● DB ●
	128010	AF 400-01-10-05	PP/ ○	PP, self-venting	-	180	MFH ○ MFQ ○	DM ● DP ● DB ●
	151424	AF 400-01-20-04	PBT/ ○	PA, self-venting	-	180	MFH ○ MFQ ○	DM ● DP ● DB ●
	128011	AF 400-01-20-05	PBT/ ○	PA, self-venting	-	180	MFH ○ MFQ ○	DM ● DP ● DB ●
2:1 400mL	112407	AF 400-02-10-01	PP/ ○	PP, self-venting	-	175	MFH ○ MFQ ○	DM ● DP ● DB ●
	113679	AF 400-02-10-02	PP/ ○	PP, self-venting	-	175	MFH ○ MFQ ○	DM ● DP ● DB ●
	128959	AF 400-02-10-05	PP/ ○	PP, self-venting	-	175	MFH ○ MFQ ○	DM ● DP ● DB ●
	112408	AF 400-02-30-01	PA/ ○	PA, self-venting	-	175	MFH ○ MFQ ○	DM ● DP ● DB ●
4:1 400mL	112397	AF 400-04-10-01	PP/ ○	PP, self-venting	-	170	MFHX ● MFQX ●	DM ● DP ● DB ●
	116140	AF 400-04-20-01	PBT/ ○	PA, self-venting	-	170	MFHX ● MFQX ●	DM ● DP ● DB ●
10:1 400mL	113745	AF 400-10-10-01	PP/ ○	PP, self-venting	-	165	MFHX ● MFQX ●	DM ● DP ● DB ●
	116612	AF 400-10-10-05	PP/ ○	PP, self-venting	-	165	MFHX ● MFQX ●	DM ● DP ● DB ●
	116089	AF 400-10-20-01	PBT/ ○	PA, self-venting	-	165	MFHX ● MFQX ●	DM ● DP ● DB ●
	116306	AF 400-10-20-03	PBT/ ○	PA, self-venting	-	165	MFHX ● MFQX ●	DM ● DP ● DB ●
	116700	AF 400-10-20-05	PBT/ ○	PA, self-venting	-	165	MFHX ● MFQX ●	DM ● DP ● DB ●

MIXPAC™ K-System Overview

2.5/5/10mL Industrial Kit

ACCESSORIES

Accessories

	ID	Article
	102267	IOR 209-20
	102272	IOT 212-20

Outlet Tip



MIXER



CARTRIDGE / PLUNGER

3mL



2.5mL

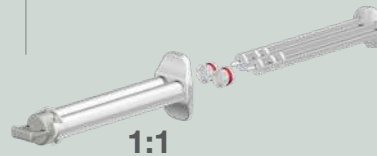

5mL

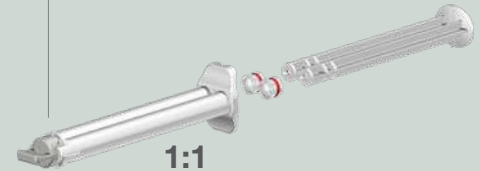

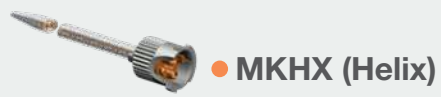

10mL

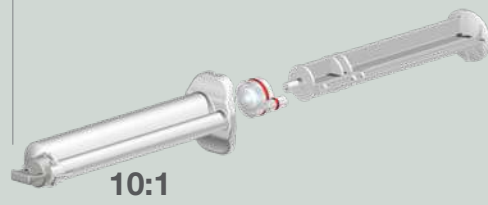
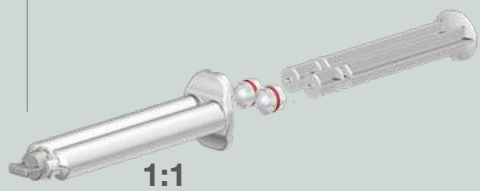

MIXPAC™ K-System Cartridge Set

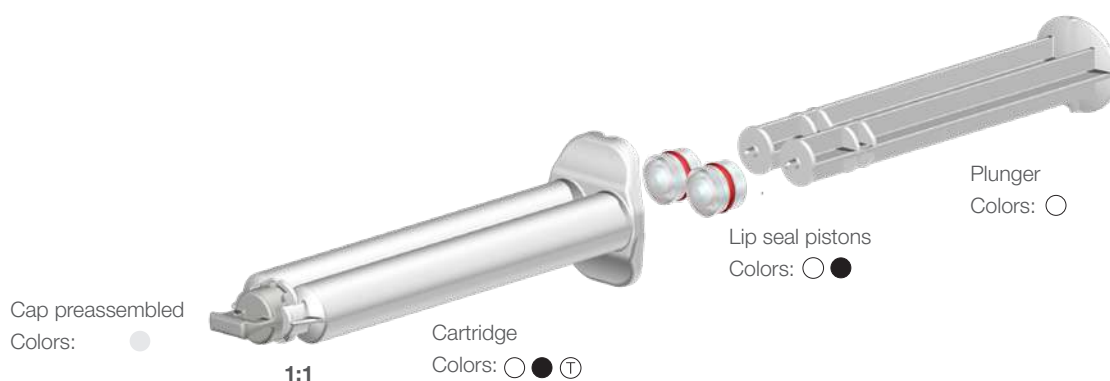

10 Industrial Kit

Cartridge Assembly 2.5-10mL



Ratio Set/ Volume	ID	Article	Cartridges Material/Color	Plunger Color	Piston Type	Units/ Box	Mixer Technology
1:1 2.5mL	116436	KK 002-01-10-01	PP/○		HDPE, solid lip seal	2000	MKH ○
	103128	PLH 002-01-45		○		2000	
1:1 3mL	301643	KK 003-01-10-01	PP/⊕	○	HDPE, solid lip seal integrated plunger	36000	
	301618	KK 003-01-10-02	PP/⊕	●	HDPE, solid lip seal integrated plunger	1800	
1:1 5mL	116438	KK 005-01-10-01	PP/○		HDPE, solid lip seal	1500	MKH ○
	116667	KK 005-01-10-02	PP/⊕		HDPE, black, solid lip seal	1500	MKH ○
	116764	KK 005-01-10-05	PP/⊕		HDPE, solid lip seal with silicone O-ring	1500	MKH ○
	116861	KK 005-01-10-06	PP/●		Silicone, solid lip seal	1500	MKH ○
	113403	PLH X05-01-45		○		2000	
	128616	KK 005-01-10-07	PP/○	○	PP, solid lip seal integrated plunger	1500	MKH ○
1:1 10mL	116440	KK 010-01-10-01	PP/○		HDPE, solid lip seal	500	MKH ○
	128200	KK 010-01-10-02	PP/⊕		HDPE, solid lip seal	500	MKH ○
	116763	KK 010-01-10-05	PP/⊕		HDPE, solid lip seal with silicone O-ring	500	MKH ○
	113401	PLH X10-01-45		○		1000	
10:1 10mL	116442	KK 010-10-10-01	PP/○		HDPE, solid lip seal	500	MKHX ●
	116571	KK 010-10-20-01	PBT/○		HDPE, solid lip seal	500	MKHX ●
	113371	PLH X10-10-45		○		1000	

Matching mixers

	ID	Article	Number of Elements	Inner Diameter Ø mm/inch	Waste Volume (mL)	Units/ Box	Outlet Tip				Accessories	
							Stepped Tip (T)	Straight Tip (D)	Luer Slip Tip (L)	Tapered Tip (S)	IOT 212-20	IOR 209-20
1:1/2:1 MKH 	114252	MKH 02-08D	8	2.5/0.098	0.14	9000	✓				✓	✓
	114246	MKH 02-08S	8	2.5/0.098	0.19	9000			✓			
	114253	MKH 02-12D	12	2.5/0.098	0.23	8000	✓				✓	✓
	117249	MKH 02-12S	12	2.5/0.098	0.23	8000			✓			
	115686	MKH 02-16S	16	2.5/0.098	0.27	7000			✓			
	114254	MKH 03-12D	12	3.2/0.126	0.39	6000	✓				✓	✓
	114250	MKH 03-12S	12	3.2/0.126	0.39	6000			✓			
	114251	MKH 03-16S	16	3.2/0.126	0.49	4000			✓			
4:1/10:1 MKHX 	114260	MKHX 02-08D	8	2.5/0.098	0.19	9000	✓				✓	✓
	114255	MKHX 02-08S	8	2.5/0.098	0.19	9000			✓			
	114261	MKHX 02-12D	12	2.5/0.098	0.23	8000	✓				✓	✓
	114256	MKHX 02-12S	12	2.5/0.098	0.23	8000			✓			
	114257	MKHX 02-16S	16	2.5/0.098	0.27	7000			✓			
	114262	MKHX 03-12D	12	3.2/0.126	0.39	6000	✓				✓	✓
	114258	MKHX 03-12S	12	3.2/0.126	0.39	6000			✓			
	114259	MKHX 03-16S	16	3.2/0.126	0.49	4000			✓			

MIXPAC™ Blueline Overview 400mL Industrial Set

ACCESSORIES

MIXER



CARTRIDGE

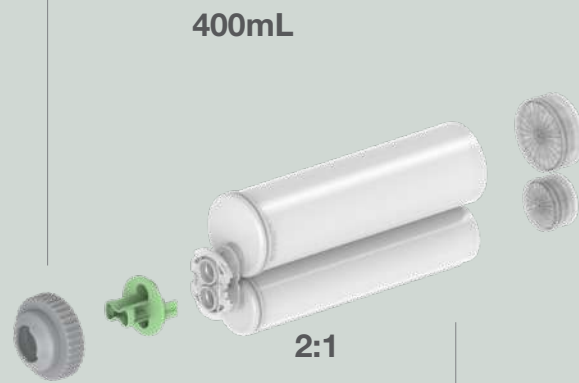

DISPENSER



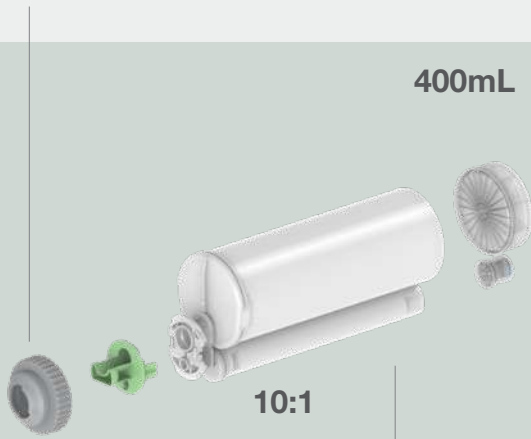

MIXPAC™ Blueline Cartridge Set

400 Industrial Set

Cartridge Assembly 400mL





Preassembled nose plug, bigger outlet
Colors grey: ●

Cartridge
Colors: ⊗



Lip seal pistons
Colors: ●

Ratio Set/ Volume	ID	Article	Cartridges Material/Color	Lip seal pistons Material	O-ring	Units/ Box	Mixer Technology	Matching Dispenser
2:1 400mL	154087	ABL 400-02-10-01	PP/ ⊗	PP, self-venting	-	180	MBLT ○	DM ● DP ●
10:1 400mL	154102	ABL 400-10-10-01	PP/ ⊗	PP, self-venting	-	160	MBLTX ●	DM ● DP ●

Matching mixers

	ID	Article	Number of Elements	Inner Diameter Ø mm/inch	Waste Volume (mL)	Units/ Box	Outlet Tip			
							Stepped Tip (T)	Straight Tip (D)	Luer Slip Tip (L)	V Tip (V)
2:1 MBLT 	154011	MBLT 14-12T	12	14.0/ 0.551	18.92	800	✓			
10:1 MBLTX 	153993	MBLTX 14-16V	16	14.0/ 0.551	23.48	580			✓	

Matching dispensers

	ID	Article	Ratio				Force (kN)
			1:1	2:1	4:1	10:1	
DM dispenser manual 	114399	DM 400-01	✓	✓			6.4
	114401	DM 400-10				✓	6.4
DP dispenser pneumatic 	114466	DP 400-100-01	✓	✓			4.5
	114465	DP 400-100-10				✓	4.5
DB dispenser battery 	152605	DB2 400-50-200		✓			5.0
	152609	DB2 400-50-400				✓	5.0

MIXPAC™ Machine Mixers

Overview

Series Industrial

Mixers

Series	ID	Article	Number of Elements	Inner Diameter Ø mm/inch	Length (mm)	Units/Box	max. Operating Pressure	Outlet tip			
								Stepped Tip (T)	Straight Tip (D)	Luer Slip Tip (L)	Threaded Tip
ME Machine Mixer POM	102448	ME 05-24T	24	5.0/0.197	149.0	2000	33.0	✓			
	102449	ME 05-32T	32	5.0/0.197	188.0	2000	33.0	✓			
	102450	ME 06-24T	24	6.4/0.252	189.0	2000	30.0	✓			
	102451	ME 06-32T	32	6.4/0.252	235.0	1700	30.0	✓			
	102452	ME 06-48T	48	6.4/0.252	334.0	1000	30.0	✓			
	102453	ME 08-24T	24	8.0/0.331	223.0	1500	27.0	✓			
	102454	ME 08-32T	32	8.0/0.331	289.0	1200	27.0	✓			
	102456	ME 10-24T	24	10.0/0.394	276.0	1000	22.0	✓			
	102457	ME 10-32T	32	10.0/0.394	355.0	800	22.0	✓			
	102459	ME 13-24T	24	13.0/0.512	293.0	700	17.0	✓			
	102460	ME 13-24T-02	24	13.0/0.512	350.0	500	17.0	✓			
	102461	ME 13-32T	32	13.0/0.512	378.0	500	17.0	✓			
	102462	ME 13-32T-02	32	13.0/0.512	453.0	400	17.0	✓			
	102455	ME 1012-0832T	12+32	1.3/0.52	409.0	700	22.0	✓			
	102458	ME 1312-1032T	12+32	1.3/0.52	499.0	500	17.0		✓		
MS Machine Mixer POM	102503	MS 05-24T	24	5.0/0.197	149.0	2000	33.0	✓			
	102504	MS 05-32T	32	5.0/0.197	188.0	2000	33.0	✓			
	102505	MS 06-24T	24	6.4/0.252	186.0	2000	30.0	✓			
	102506	MS 06-32T	32	6.4/0.252	235.0	1700	30.0	✓			
	102507	MS 06-48T	48	6.4/0.252	334.0	1000	30.0	✓			
	102508	MS 06-56D	56	6.4/0.252	378.0	800	30.0		✓		
	102509	MS 06-56L	56	6.4/0.252	38.0	800	30.0			✓	
	102510	MS 08-24T	24	8.0/0.331	223.0	1500	27.0	✓			
	102511	MS 08-32T	32	8.0/0.331	289.0	1200	27.0	✓			
	102513	MS 10-18T	18	10.0/0.394	214.0	1400	22.0	✓			
	102514	MS 10-24T	24	10.0/0.394	352.0	1000	22.0	✓			
	102515	MS 10-32T	32	10.0/0.394	352.0	800	22.0	✓			
	102517	MS 13-18G	18	12.8/0.504	223.0	800	17.0				✓
	102519	MS 13-24T-02	24	13.0/0.512	350.0	500	17.0	✓			
	102518	MS 13-24T	24	13.0/0.512	293.0	700	17.0	✓			
	102522	MS 13-32G-01	32	13.0/0.512	373.0	400	17.0				✓
	102521	MS 13-32T-02	32	13.0/0.512	453.0	400	17.0	✓			
	102520	MS 13-32T	32	13.0/0.512	378.0	500	17.0	✓			
	113743	MS 13-12G	12	13.0/0.512	159.0	1000	17.0				✓
	102512	MS 1012-0832T	12+32	1.3/0.052	409.0	700	22.0	✓			
102516	MS 1312-1032D	12+32	1.3/0.052	499.0	500	17.0		✓			
MSR Rotary Mixer POM	102499	MSR 06-12T	12	6.4/0.252	111.5	2000	30.0	✓			
	102500	MSR 08-12T	12	8.0/0.331	130.0	1500	27.0	✓			
	102501	MSR 10-12T	12	10.0/0.394	155.0	1500	22.0	✓			
	102502	MSR 13-12T	12	13.0/0.512	197.0	1000	17.0	✓			

For safety reasons, MIXPAC™ shrouds must be used at all times.



7/8" 9 UNC
7/8" 14 UNF

Nut across flats
27.0 mm (1 1/16")

Shrouds

Series	ID	Article	Inner Diameter Ø mm/inch	Length (mm)	Units/ Box	Material
7/8" 9 UNC Thread	114351	SH 05-24-09	8.2/0.323	146.0	1	aluminium alloy
	114356	SH 05-32-09	8.2/0.323	185.0	1	aluminium alloy
	114352	SH 06-24-09	10.2/0.402	179.5	1	aluminium alloy
	114357	SH 06-32-09	10.2/0.402	228.5	1	aluminium alloy
	114349	SH 06-48-09	10.7/0.421	329.0	1	aluminium alloy
	114365	SH 06-56-09	10.7/0.421	383.5	1	aluminium alloy
	114353	SH 08-24-09	12.2/0.480	215.0	1	aluminium alloy
	114358	SH 08-32-09	12.2/0.480	279.0	1	aluminium alloy
	114354	SH 10-24-09	14.2/0.559	265.5	1	aluminium alloy
	114359	SH 10-32-09	14.2/0.559	341.5	1	aluminium alloy
	114366	SH 13-24-09	17.2/0.677	280.5	1	aluminium alloy
	114368	SH 13-32-09	17.2/0.677	365.5	1	aluminium alloy
	114362	SH 10-44-09	14.2/0.559 12.2/0.480	401.0	1	aluminium alloy
	114364	SH 13-44-09	17.2/0.677 14.2/0.559	503.0	1	aluminium alloy
7/8" 14 UNF Thread	114335	SH 05-24-14	8.2/0.323	146.0	1	aluminium alloy
	114340	SH 05-32-14	8.2/0.323	185.0	1	aluminium alloy
	114336	SH 06-24-14	10.2/0.402	179.5	1	aluminium alloy
	114341	SH 06-32-14	10.2/0.402	228.5	1	aluminium alloy
	114348	SH 06-48-14	10.7/0.421	329.0	1	aluminium alloy
	114347	SH 06-56-14	10.7/0.421	383.5	1	aluminium alloy
	114337	SH 08-24-14	12.2/0.480	215.0	1	aluminium alloy
	114342	SH 08-32-14	12.2/0.480	279.0	1	aluminium alloy
	114338	SH 10-24-14	14.2/0.559	265.5	1	aluminium alloy
	114343	SH 10-32-14	14.2/0.559	341.5	1	aluminium alloy
	114367	SH 13-24-14	17.2/0.677	280.5	1	aluminium alloy
	114369	SH 13-32-14	17.2/0.677	365.5	1	aluminium alloy
	114345	SH 10-44-14	14.2/0.559 12.2/0.480	401.0	1	aluminium alloy
	114346	SH 13-44-14	17.2/0.677 14.2/0.559	503.0	1	aluminium alloy

For health and safety reasons, MIXPAC™ SH Series safety shrouds must be used at all times.

Innovation in Application

Headquarters / Europe

Sulzer Mixpac Ltd
Ruetistrasse 7
9469 Haag, Switzerland
phone +41 81 772 20 00
fax +41 81 772 20 01
mixpac@sulzer.com
www.sulzer.com

USA, South America, Canada and Mexico

Sulzer Mixpac USA Inc.
8 Willow St.
Salem, NH 03079, USA
phone +1 603 893 2727
fax +1 603 893 3737
info@SulzerMixpacUSA.com
www.sulzer.com

UK and Ireland

Sulzer Mixpac (UK) Ltd.
1 Tealgate, Charnham Park
Hungerford
Berkshire, RG17 0YT
United Kingdom
Phone: +44 (0)1488 647 839
Mobile: +44 (0)7787 687 924
www.coxdispensers.com

Asia Pacific

Sulzer Mixpac China
68 Bei Dou Lu, Minhang
Shanghai 200245, China
phone +86 21 6430 68 68
fax +86 21 6430 66 88
mixpac@sulzer.com
www.sulzer.com